

KOBELCO

Performance  Design

SK 85MSR

- Bucket capacity:
0.11 – 0.35 m³
- Engine power:
53.7 kW / 2,100 min⁻¹
- Operating weight:
8,400 – 9,600 kg





SK85MSR



Performance Design

SK85MSR of KOBELCO has realised a completely new value by harmonising PERFORMANCE – greater efficiency and productivity with an increased power and speed and DESIGN – operator-based operability and comfort, refusing to accept any compromises.

In pursuit of unique and matchless machines which are unforgettable once you use them, KOBELCO will continue to rise to meet every challenge.

THE ULTIMATE IN SIMPLE AND ELEGANT DESIGN

Our pursuit of functional beauty and aesthetic sense produced a new interior design.

Jog dial

This jog dial integrates multiple functions to realise simple operations. Even with gloved hands, the operator can set various machine conditions without stress.

LED backlights

The switches and dials have LED backlights – they provide a bright, clear view in the dark and set a luxurious mood.







UNFORGETTABLE COMFORT

① Air suspension seat

A GRAMMER seat is installed as standard equipment, which achieves excellent shock absorption and superior ride comfort.

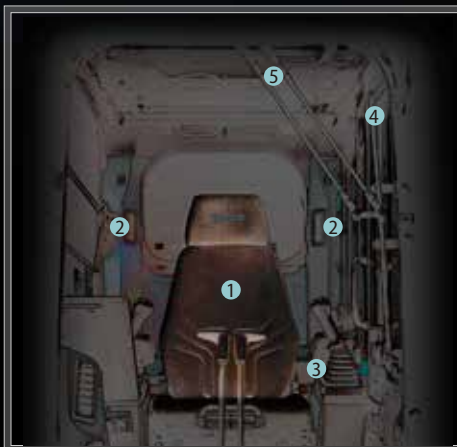

② Air conditioner blowing from the rear

Air is blown against the operator's waist and the back of their head, offering more comfortable operation.

③ Lever angles allow for comfortable operations

The operator can move the levers horizontally without twisting their wrist, which reduces the fatigue caused by the operations.



④ LED door light

The LED interior light automatically turns on when the door is opened or when the ignition is set to OFF. This ensures easy entry and exit at nighttime.

⑤ Parallel wipers secure a wide field of view



KOBELCO

ECO

04:33



SETTING MENU



PICTURE OF CAMERA



CLOCK SETTING



SCREEN BRIGHTNESS



MAINTENANCE



CONSUMPTION



START PASSWORD



LANGUAGE SELECTION

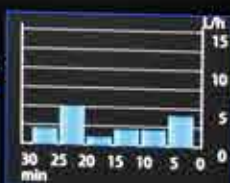

AVERAGE FUEL CONSUMPTION 4L/h
OPERABLE TIME 12 h



FLOW RATE 128 L/min

A WIDER VIEW BRINGS A WIDER RANGE OF USE

10-inch colour monitor (the largest in the industry)

The easy-to-operate menu screen facilitates reading of important information. Images from the built-in cameras can be checked on the large screen, which helps secure safety. In addition, each icon has become easy to recognise. A password is required when starting the engine for greater security.



The right camera and rear camera (right side view mode)

The right camera and rear camera (straight view mode)

The right camera and rear camera (right side view mode)

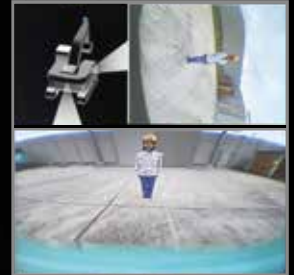

The right camera and rear camera (straight view mode)



The bird's-eye view



The eagle-eye view (option)

Right and rear cameras

Images from the right camera and rear camera are displayed together on the large colour monitor. The right camera view can be selected between the straight view mode and right side view mode. In addition, the bird's-eye view mode can also be selected. As an optional setting, the eagle eye view mode can also be selected.

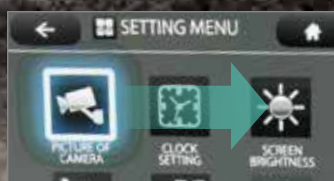

Screen display linked with the jog dial operation

The jog dial can be operated as desired without causing stress. Turn the jog dial to the right or left to select an item and press the dial to confirm the selection.



EXPERIENCING A COMPETENT PERFORMANCE

Our high-power engine complies with STAGE V emission regulations

Compared to previous models, the engine output is significantly increased, which thereby shortens the digging cycle time remarkably. It attains high performances without reducing the speed even when heavy a load is applied or when travelling on a slope.



Model :YANMAR 4TNV98CT

Engine output

Increased by **27.9%**

(Compared to the SK85MSR-3E model)

»» Digging cycle time Shortened by **15%**

(Compared to the SK85MSR-3E model)

Loaded boom lifting speed

Increased by **38%**

(Compared to the SK85MSR-3E model)

Arm digging speed

Increased by **37%**

(Compared to the SK85MSR-3E model)



»» Hill-climbing speed

Increased by **22%**

(Compared to the SK85MSR-3E model)



GREATER MULTI-FUNCTION CAPABILITIES



Attachment mode





The flow-rate modes of the bucket, breaker, nibbler, and rotating grapple are set before delivery, which allows you to start operating immediately. Mode settings for other attachments, such as the tilt rotator, can easily be added or changed.





TYPES OF ATTACHMENT MODE

	TYPE	MODE	OBJECTIVE OF MODE
CURRENT MODE		Bucket	Balance in operations such as levelling can be adjusted.
		Breaker	Arm regeneration function considering front attachment weight is provided beforehand.
		Nibbler (crusher)	Change of arm speed due to nibbler (crusher) opening/closing is reduced.

	TYPE	MODE	OBJECTIVE OF MODE
NEWLY ADDED MODE		Rotating grapple	Swing operation on slope while raising attachment/equipment becomes possible. Boom 2-speed systems is controlled by proportional valve.
		Processor	N&B flow rate is set to maximum specifically. Regeneration of arm in operation while using front attachment is changed.
		Thumb bucket	Swing operation while raising attachment/equipment and opening thumb bucket becomes possible.
		Tilt rotator	When combined operation with arm is performed, hydraulic interference is prevented.
		Spare mode for custom setting	This mode should be customized at each field. This is provided for front attachment other than those described above.

NON-STOP OPERATION BY iNDr

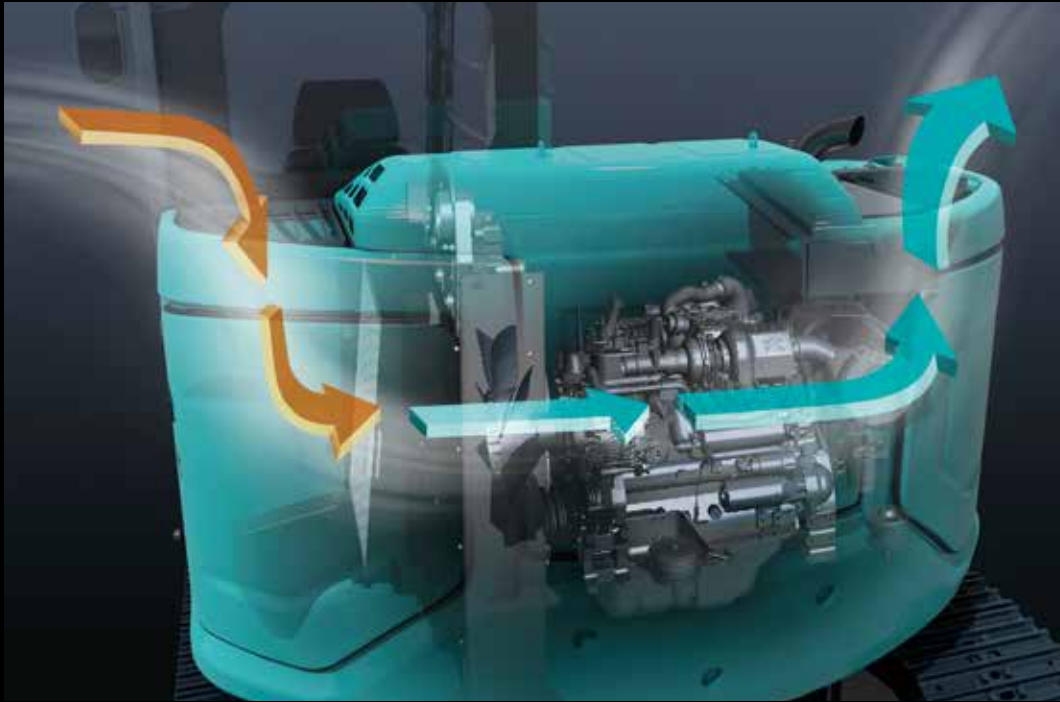

iNDr Filter

A high-density mesh filter blocks dust intruding during air intake. This prevents the cooling device and the air cleaner from clogging with dust and maintains their performances. The ridges of the corrugated filter allow the air to pass through, and the grooves collect the dust, which prevents the filter from clogging.

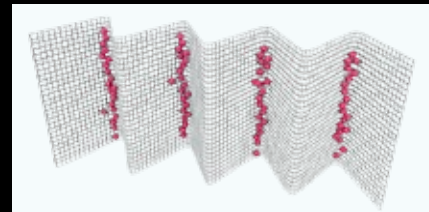

How the filter catches dust



Maintainable on the ground

Portions that require daily maintenance, such as lubrication, have been laid out in easily accessible locations.



Easily removable bonnet

The bonnet can be detached by removing only the bolts, allowing easy access to the inside.

CONVENIENT AND SENSIBLE EQUIPMENT



Engine start password

A password is required when starting the engine for greater security. The initial password must be set at our workshop.

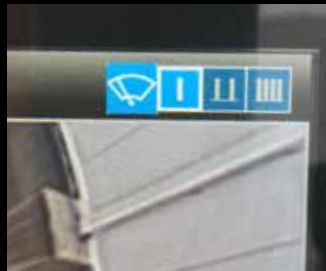

Wiper adjustment function

In addition to the intermittent wiper mode and continuous wiper mode, the one-time wiper mode was added.



Parallel wipers/Roll sun shade



Console mount

The console-integrated seat allows for comfortable operation.



AM/FM Bluetooth® (hands-free) radio



USB port/12 V power outlet



Smartphone holder

You can use the holder with your smartphone connected to the USB port.



Built-in rear camera/right camera



Openable FOPS guard

The openable guard allows for easy maintenance.



Increased clearance between the upper body and the shoes



Remote control fuel drain cock



Engine oil drain cock



KOBELCO MONITORING EXCAVATOR SYSTEM



Remote Monitoring for Peace of Mind
 KOMEXS (Kobelco Monitoring Excavator System) uses satellite communication and internet to relay data, and therefore can be deployed in areas where other forms of communication are difficult. When a hydraulic excavator is fitted with this system, data on the machine's operation, such as operating hours, location, fuel consumption, and maintenance status can be obtained remotely.

Direct Access to Operational Status

Location Data

Accurate location data can be obtained even from sites where communications are difficult.

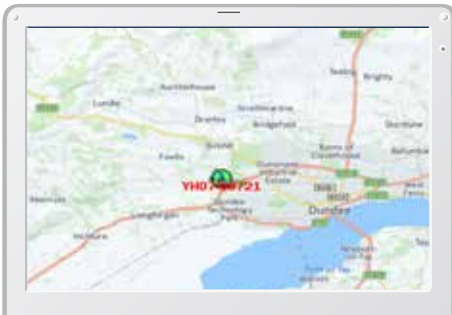

Latest location

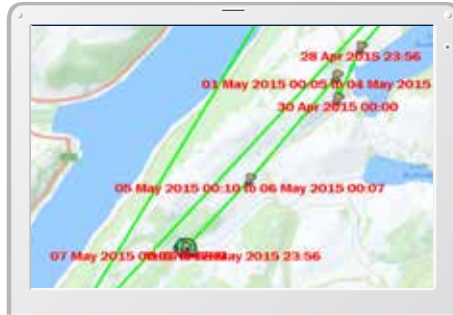

Location records

Type of Operation	Working Hrs	Ratio
Total Working Hrs	159 Hrs	100 %
Digging Hrs	72.2 Hrs	43 %
Traveling Hrs	18.3 Hrs	11 %
Idle Hrs	15.9 Hrs	9 %
Opt Alt Hrs	52.5 Hrs	37 %
Crane Mode Hrs	0 Hrs	0 %

Work data

Operating Hours

- A comparison of operating times of machines at multiple locations shows which locations are busier and more profitable.
- Operating hours on site can be accurately recorded, for running time calculations needed for rental machines, etc.

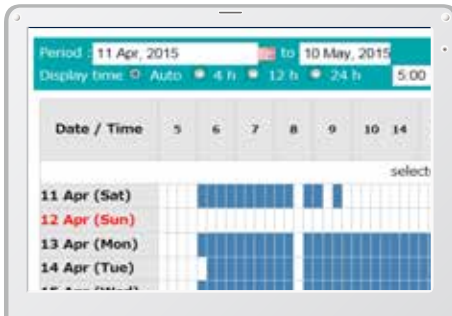

Daily report

Fuel Consumption Data

Data on fuel consumption and idling times can be used to indicate improvements in fuel consumption.

Work mode	Working Hrs	Total Fuel Consumption
H mode	2:06	24.5 L
S mode	0:00	0.0 L
E mode	169:19	1489.7 L
TOTAL	171:25	1514.2 L

Fuel consumption

Graph of Work Content

The graph shows how working hours are divided among different operating categories, including digging, idling, travelling and optional operations.



Work status

Maintenance Data and Warning Alerts

Machine Maintenance Data

- Provides maintenance status of separate machines operating at multiple sites.
- Maintenance data is also relayed to KOBELCO service personnel, for more efficient planning of periodic servicing.

Model	Serial No.	Hour Meter	Engine Oil
SK135SRLC-3/SK140SRL	YH07-09221	734 Hr	434
SK135SRLC-3/SK140SRL	YH07-09289	73 Hr	429
SK210LC-9	YQ13-10454	960 Hr	58
SK210LC-9	YQ13-10481	549 Hr	498
SK75SR-	YT08-20374		

Maintenance

Warning Alerts

This system warns an alert if an anomaly is sensed, preventing damage that could result in machine downtime.

Alarm Information Can Be Received through E-mail

Alarm information or maintenance notice can be received through E-mail, using a computer or cell phone.



Alarm messages can be received on mobile device.

Daily/Monthly Reports

Operational data downloaded onto a computer helps in formulating daily and monthly reports.

Security System

Engine Start Alarm

The system can be set an alarm if the machine is operated outside designated time.

Engine start alarm outside prescribed work time

Area Alarm

It can be set an alarm if the machine is moved out of its designated area to another location.

Alarm for outside of reset area

Specifications



Engine

Model	YANMAR 4TNV98CT
Type	Four-stroke, liquid-cooled, direct injection diesel, turbo charged complies with EU Stage V exhaust emission regulation
No. of cylinders	4
Bore and stroke	98 mm x 110 mm
Displacement	3.318 L
Rated power output	52.3 kW/2,100 min ⁻¹ (ISO 9249: with fan) 53.7 kW/2,100 min ⁻¹ (ISO 14396: without fan)
Max. torque	293 N·m/1,365 min ⁻¹ (ISO 9249: with fan) 296 N·m/1,365 min ⁻¹ (ISO 14396: without fan)



Hydraulic system

Pump	
Type	Variable displacement piston pumps + one gear pump
Max. discharge flow	2 x 72.5 L/min 1 x 19 L/min
Relief valve setting	
Boom, arm and bucket	29.4 Mpa {300 kgf/cm ² }
Travel circuit	29.4 Mpa {300 kgf/cm ² }
Swing circuit	24.5 Mpa {250 kgf/cm ² }
Control circuit	5.0 Mpa {50 kgf/cm ² }
Pilot control pump	Gear type
Main control valves	13-spool
Oil cooler	Air cooled type



Swing system

Swing motor	One fixed displacement piston motor
Brake	Hydraulic; locking automatically when the swing control lever is in the neutral position
Parking brake	Wet multiple plate
Swing speed	11.5 min ⁻¹
Tail swing radius	1,650 mm
Swing torque	17 kN·m



Attachments

Backhoe bucket and combination

Use	Backhoe bucket							
	Standard	Narrow						Wide
Bucket capacity	ISO heaped m ³	0.28	0.11	0.14	0.18	0.22	0.35	
	Struck m ³	0.25	0.09	0.12	0.14	0.18	0.26	
Opening width	With side cutter mm	650	—	480	550	650	850	
	Without side cutter mm	680	400	410	480	580	780	
No. of teeth		4	3	3	3	4	4	
Bucket weight	kg	210	190	160	170	190	—	
Combination	1.87 m arm	⊙	○	○	○	○	△	
	2.13 m arm	△	○	○	○	⊙	—	

⊙ Standard ○ Recommended △ Loading only



Travel system

Travel motors	Variable displacement piston, two-speed motors
Travel brakes	Hydraulic brake
Parking brakes	Wet multiple plate
Travel shoes	39 each side
Travel speed	5.0/2.7 km/h
Drawbar pulling force	77 kN (ISO 7464)
Gradeability	58% {30°}



Cab & control

Cab	
All-weather, sound-suppressed steel cab mounted on the silicon-sealed viscous mounts and equipped with a heavy, insulated floor mat	
Control	
Two hand levers and two foot pedals for travel	
Two hand levers for excavating and swing	
Electric rotary-type engine throttle	
Noise levels	
External	98 dB(A)
Operator	73 dB(A)



Boom, arm & bucket

Boom cylinders	110 mm x 916 mm
Arm cylinder	95 mm x 839 mm
Bucket cylinder	85 mm x 762 mm



Dozer blade

Dozer cylinder	145 mm x 189 mm
Dimension	2,300 mm {for 450 mm shoe} (width) x 460 mm (height)*
Working range	500 mm (up) x 500 mm (down)

*Dozer width is changed according to the shoe width difference.



Refilling capacities & lubrications

Fuel tank	120 L
Cooling system	12.8 L
Engine oil	11.8 L
Travel reduction gear	2 x 1.3 L
Swing reduction gear	1.5 L
Hydraulic oil tank	44 L tank oil level
	84 L hydraulic system



Working ranges

Unit: m

Boom	3.50 m	
Range	1.87 m	2.13 m
a - Max. digging reach	7.24	7.50
b - Max. digging reach at ground level	7.07	7.34
c - Max. digging depth	4.18	4.44
d - Max. digging height	7.01	7.23
e - Max. dumping clearance	4.98	5.18
f - Min. dumping clearance	1.95	1.70
g - Max. vertical wall digging depth	3.42	3.75
h - Min. swing radius	2.70	2.80
i - Horizontal digging stroke at ground level	3.11	3.51
j - Digging depth for 2.4 m (8') flat bottom	3.82	4.12
Bucket capacity ISO heaped m ³	0.28	0.22



Dimensions

Unit: mm

Boom	3.50 m	
Arm length	1.87 m	2.13 m
A Overall length	6,730	6,750
B Overall height (to top of boom)	2,400	2,550
C Overall width (narrow specification)	2,300** (2,150)	
D Overall height (to top of cab)	2,570	
E Ground clearance of rear end*	720	
F Ground clearance*	350	
G Tail swing radius (add on counter weight)	1,650 (1,740)	
G' Distance from centre of swing to rear end	1,650	
H Tumbler distance	2,210	
I Overall length of crawler	2,830	
J Track gauge (narrow specification)	1,850 (1,700)	
K Shoe width	450	
L Overall width of upperstructure	2,300	
M Dozer blade (up/down)	500 (29°) / 500	

*Without including height of shoe lug **450 mm shoe

Digging force (ISO 6015)

Unit: kN {kgf}

Arm length	1.87 m	2.13 m
Bucket digging force	60.3 {6,150}	
Arm crowding force	37.1 {3,780}	33.7 {3,440}

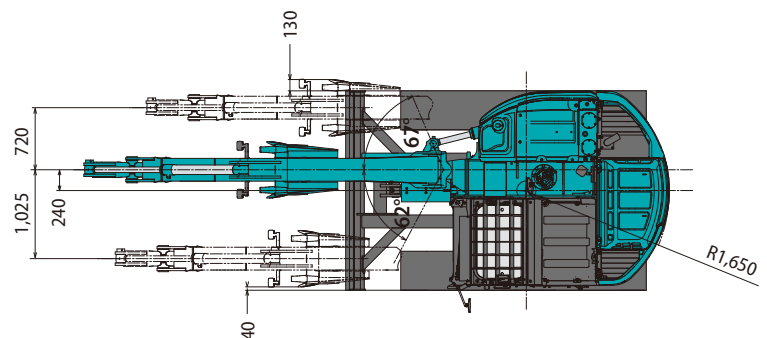
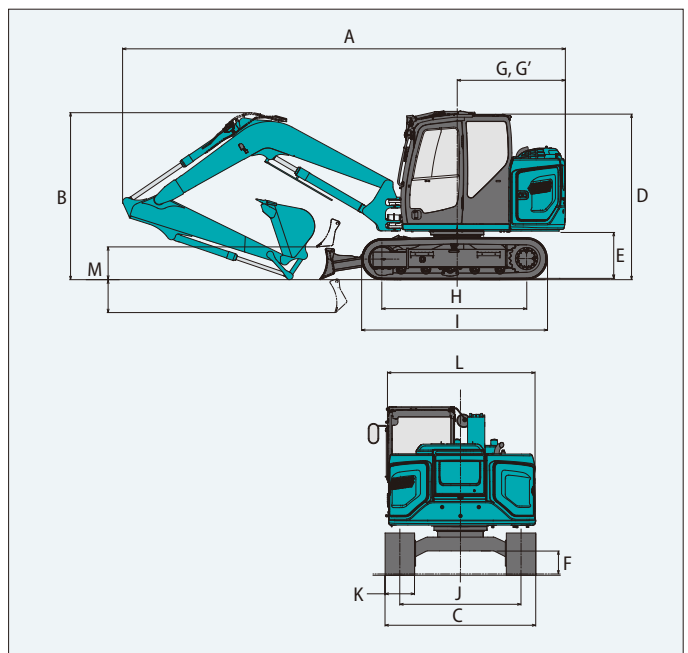
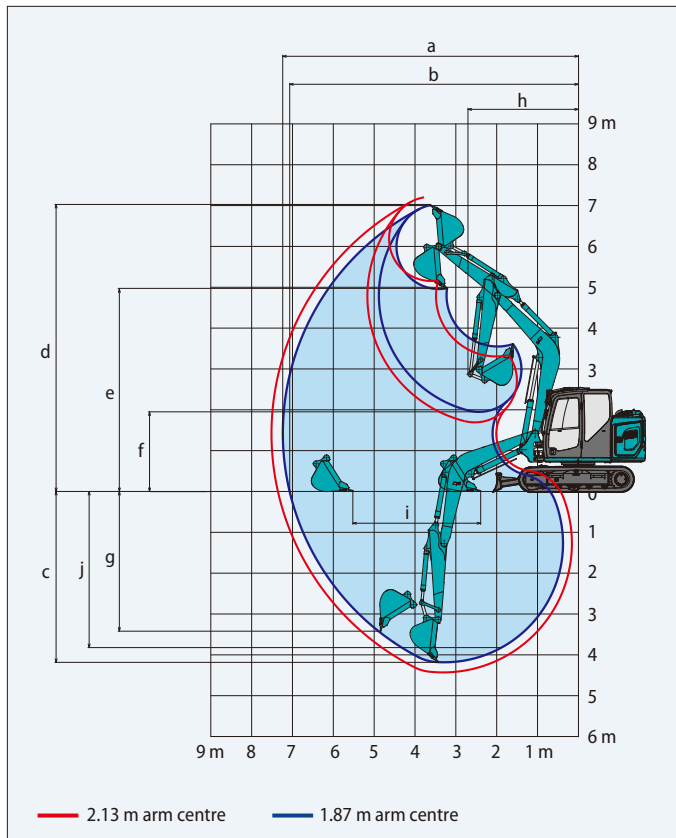

Operating weight & ground pressure

In standard trim, with standard boom, 2.13 m arm, and 0.22 m³ ISO heaped bucket.

Shaped		Triple grouser shoes (even height)		Rubber pad shoes	Rubber shoes	BS Geogrip shoes
Shoe width	mm	600		450		
Overall width of crawler	mm	2,450		2,300		
Ground pressure	kPa	30	39	40	38	39
Operating weight	kg	8,850	8,600	8,930	8,480	8,650

Specifications

Two piece boom specifications



Working ranges

Unit: m

Boom	Two piece boom	
	1.87 m	2.13 m
Range	Arm	
a- Max. digging reach	7.75	8.01
b- Max. digging reach at ground level	7.59	7.86
c- Max. digging depth	4.31	4.57
d- Max. digging height	7.92	8.16
e- Max. dumping clearance	5.84	6.09
f- Min. dumping clearance	1.09	0.825
g- Max. vertical wall digging depth	3.73	4.00
h- Min. swing radius	2.53	2.65
i- Horizontal digging stroke at ground level	4.48	5.00
j- Digging depth for 2.4 m (8') flat bottom	4.16	4.43
Bucket capacity ISO heaped m ³	0.28	0.22

Digging force (ISO 6015)

Unit: kN

Arm length	1.87 m	2.13 m
Bucket digging force	60.3	
Arm crowding force	37.1	33.7



Dimensions

Unit: mm

Boom	Two piece boom	
	1.87 m	2.13 m
A Overall length	7,220	7,230
B Overall height (to top of boom)	2,400	2,530
C Overall width of crawler (narrow specification)	2,300 (2,150)	
D Overall height (to top of cab)	2,570	
E Ground clearance of rear end*	720	
F Ground clearance*	350	
G Tail swing radius	1,650	

*Without including height of shoe lug

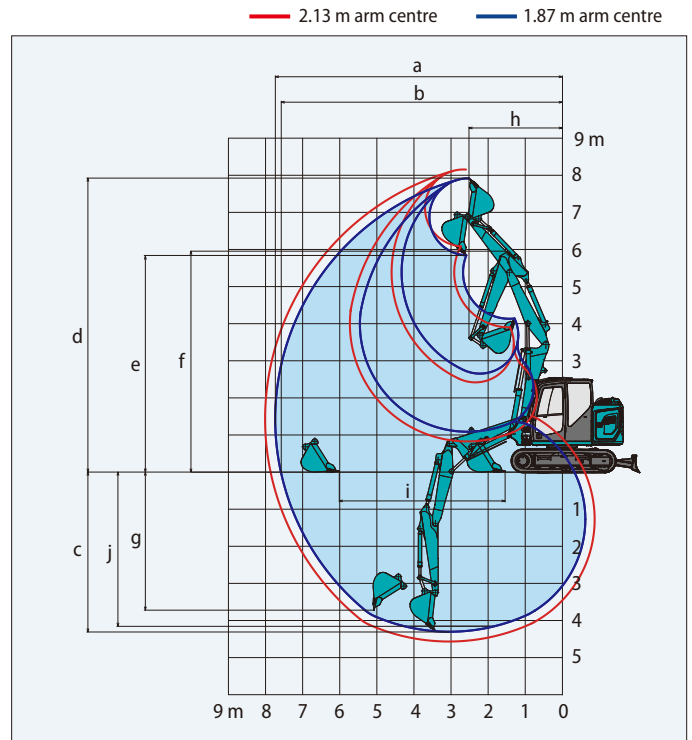

H Tumbler distance	2,210
I Overall length of crawler	2,830
J Track gauge (narrow specification)	1,850 (1,700)
K Shoe width	450
L Overall width of upperstructure	2,300
M Dozer blade (up/down)	500(29°)/500

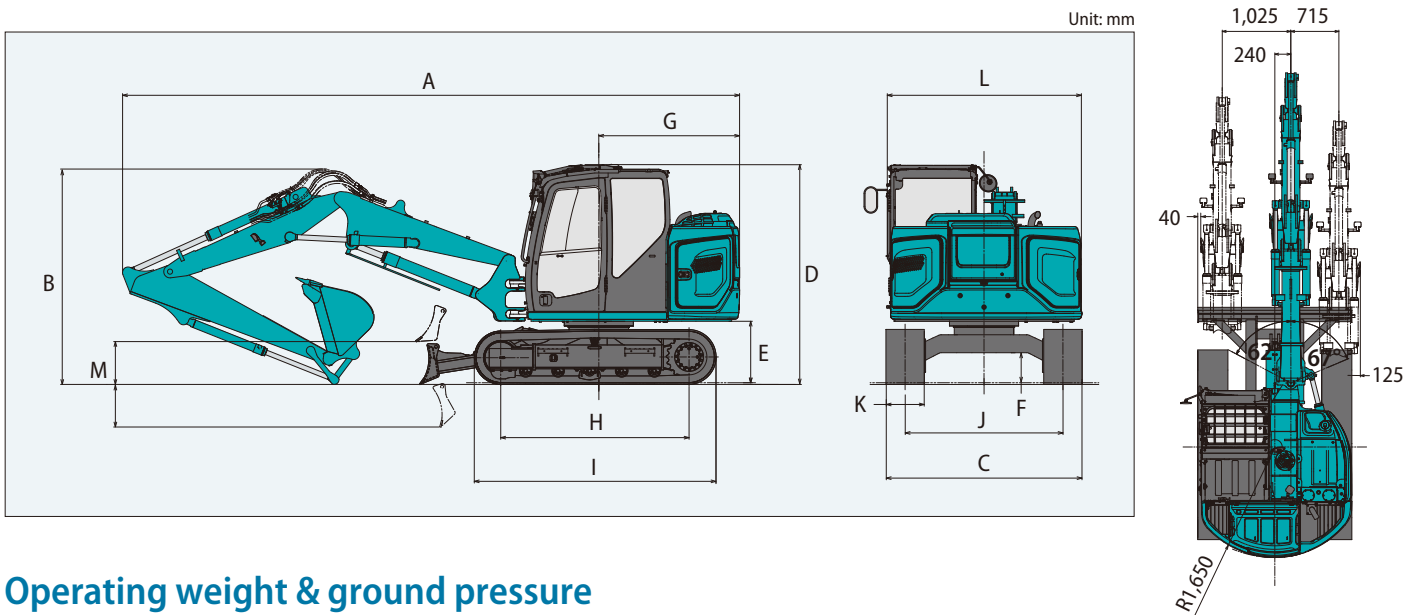

Operating weight & ground pressure

In standard trim, with standard boom, 2.13 m arm, and 0.22 m³ ISO bucket.

Shaped		Triple grouser shoes (even height)		Rubber pad shoes	Rubber shoes	BS Geogrip shoes
		31	40	41	40	40
Shoe width	mm	600			450	
Overall width of crawler	mm	2,450			2,300	
Ground pressure	kPa	31	40	41	40	40
Operating weight	kg	9,180	8,930	9,250	8,800	8,970

Lifting capacities

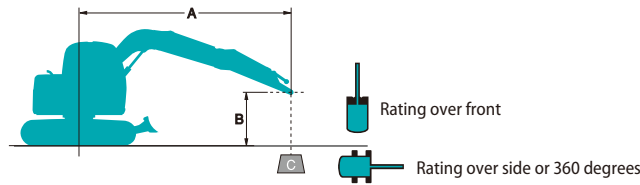

A: Reach from swing centreline to arm top
 B: Arm top height above/below ground
 C: Lifting capacities in Kilograms
 Bucket: Without bucket
 Relief valve setting: 29.4 MPa {300 kgf/cm²}

Mono boom specifications

SK85MSR		Arm: 1.87 m	Bucket: Without	Counterweight: 700 kg		Shoe: 450 mm		Dozer: Blade up				
		1.5 m		3.0 m		4.5 m		6.0 m		At max. reach		
B												Radius
6.0 m	kg									*1,830	*1,830	3.45 m
4.5 m	kg					1,910	1,650			*1,420	1,290	5.19 m
3.0 m	kg			*3,280	*3,000	1,830	1,580			1,160	1,000	5.96 m
1.5 m	kg					1,700	1,460	1,110	960	1,050	910	6.19 m
G.L.	kg			2,970	2,440	1,610	1,370			1,080	930	5.99 m
-1.5 m	kg	*3,950	*3,950	3,000	2,470	1,600	1,360			1,290	1,100	5.26 m
-3.0 m	kg			*2,280	*2,280					*1,750	*1,750	3.63 m

SK85MSR		Arm: 2.13 m	Bucket: Without	Counterweight: 700 kg		Shoe: 450 mm		Dozer: Blade up				
		1.5 m		3.0 m		4.5 m		6.0 m		At max. reach		
B												Radius
6.0 m	kg									*1,460	*1,460	3.97 m
4.5 m	kg					*1,860	1,670			*1,170	1,160	5.52 m
3.0 m	kg					1,840	1,590	1,140	990	1,070	930	6.23 m
1.5 m	kg					1,700	1,460	1,100	950	980	840	6.46 m
G.L.	kg			2,950	2,420	1,600	1,360	1,060	910	1,000	860	6.26 m
-1.5 m	kg	*3,420	*3,420	2,960	2,430	1,570	1,340			1,170	1,000	5.58 m
-3.0 m	kg			*2,860	2,530					*1,800	1,580	4.12 m

SK85MSR		Arm: 2.13 m	Bucket: Without	Counterweight: 700 kg + 300 kg		Shoe: 450 mm		Dozer: Blade up				
		1.5 m		3.0 m		4.5 m		6.0 m		At max. reach		
B												Radius
6.0 m	kg									*1,460	*1,460	3.97 m
4.5 m	kg					*1,860	1,830			*1,170	*1,170	5.52 m
3.0 m	kg					2,030	1,760	1,270	1,110	*1,130	1,040	6.23 m
1.5 m	kg					1,890	1,630	1,230	1,070	1,090	950	6.46 m
G.L.	kg			3,300	2,710	1,790	1,530	1,190	1,030	1,120	970	6.26 m
-1.5 m	kg	*3,420	*3,420	3,300	2,720	1,760	1,500			1,310	1,130	5.58 m
-3.0 m	kg			*2,860	2,820					*1,800	1,770	4.12 m

SK85MSR		Arm: 2.13 m	Bucket: Without	Counterweight: 1,050 kg		Shoe: 450 mm		Dozer: Blade up				
		1.5 m		3.0 m		4.5 m		6.0 m		At max. reach		
B												Radius
6.0 m	kg									*1,460	*1,460	3.97 m
4.5 m	kg					*1,860	1,850			*1,170	*1,170	5.52 m
3.0 m	kg					2,040	1,770	1,280	1,120	*1,130	1,050	6.23 m
1.5 m	kg					1,900	1,640	1,240	1,080	1,100	960	6.46 m
G.L.	kg			3,320	2,730	1,800	1,540	1,200	1,040	1,130	980	6.26 m
-1.5 m	kg	*3,420	*3,420	3,330	2,740	1,770	1,520			1,320	1,140	5.58 m
-3.0 m	kg			*2,860	2,840					*1,800	1,780	4.12 m

Lifting capacities

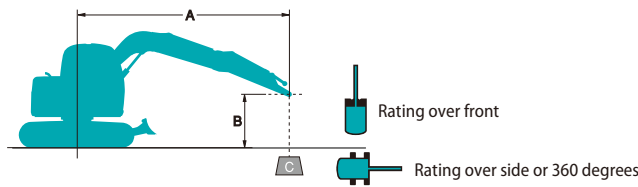

A: Reach from swing centreline to arm top
 B: Arm top height above/below ground
 C: Lifting capacities in Kilograms
 Bucket: Without bucket
 Relief valve setting: 29.4 MPa (300 kgf/cm²)

Mono boom specifications

SK85MSR		Arm: 1.87 m	Bucket: Without	Counterweight: 1,050 kg + 300 kg		Shoe: 450 mm		Dozer: Blade up		At max. reach		Radius
B	A	1.5 m		3.0 m		4.5 m		6.0 m				
	6.0 m	kg									*1,830	*1,830
4.5 m	kg					*2,030	2,000			*1,420	*1,420	5.19 m
3.0 m	kg			*3,280	*3,280	2,220	1,930			*1,380	1,250	5.96 m
1.5 m	kg					2,090	1,810	1,380	1,200	1,310	1,140	6.19 m
G.L.	kg			3,680	3,050	2,000	1,720			1,350	1,170	5.99 m
-1.5 m	kg	*3,950	*3,950	3,710	3,070	1,990	1,710			1,610	1,390	5.26 m
-3.0 m	kg			*2,280	*2,280					*1,750	*1,750	3.63 m











SK85MSR		Arm: 2.13 m	Bucket: Without	Counterweight: 1,050 kg + 300 kg		Shoe: 450 mm		Dozer: Blade up		At max. reach		Radius
B	A	1.5 m		3.0 m		4.5 m		6.0 m				
	6.0 m	kg									*1,460	*1,460
4.5 m	kg					*1,860	*1,860			*1,170	*1,170	5.52 m
3.0 m	kg					*2,170	1,940	1,410	1,240	*1,130	*1,130	6.23 m
1.5 m	kg					2,090	1,810	1,370	1,190	*1,200	1,070	6.46 m
G.L.	kg			3,660	3,030	1,990	1,710	1,330	1,160	1,250	1,090	6.26 m
-1.5 m	kg	*3,420	*3,420	3,670	3,030	1,960	1,680			1,460	1,270	5.58 m
-3.0 m	kg			*2,860	*2,860					*1,800	*1,800	4.12 m











Two piece boom specifications







SK85MSR		Arm: 1.87 m	Bucket: Without	Counterweight: 700 kg		Shoe: 450 mm		Dozer: Blade up		At max. reach		Radius
B	A	1.5 m		3.0 m		4.5 m		6.0 m				
	6.0 m	kg									1,890	1,620
4.5 m	kg					*1,720	1,590			1,150	990	5.81 m
3.0 m	kg			3,310	2,720	1,710	1,450	1,060	900	910	780	6.49 m
1.5 m	kg			2,850	2,300	1,520	1,280	990	840	830	700	6.70 m
G.L.	kg	*3,050	*3,050	2,080	2,080	1,420	1,180	950	790	840	710	6.52 m
-1.5 m	kg	*5,310	*5,310	2,710	2,180	1,410	1,170			980	820	5.87 m
-3.0 m	kg			*2,620	2,330					*760	*760	4.54 m





SK85MSR		Arm: 2.13 m	Bucket: Without	Counterweight: 700 kg		Shoe: 450 mm		Dozer: Blade up		At max. reach		Radius
B	A	1.5 m		3.0 m		4.5 m		6.0 m				
	6.0 m	kg					1,850	1,580			1,620	1,390
4.5 m	kg					1,870	1,610	1,070	910	1,050	890	6.12 m
3.0 m	kg			3,410	2,820	1,730	1,470	1,060	900	840	710	6.76 m
1.5 m	kg			2,840	2,290	1,530	1,280	990	830	770	650	6.97 m
G.L.	kg	*2,650	*2,650	*1,730	*1,730	1,400	1,160	930	780	780	650	6.79 m
-1.5 m	kg	*4,650	*4,650	2,640	2,120	1,380	1,140	910	750	890	750	6.18 m
-3.0 m	kg	*6,570	*6,570	2,840	2,290	*1,160	*1,160			*860	*860	4.95 m

Two piece boom specifications

SK85MSR		Arm: 2.13 m		Bucket: Without		Counterweight: 700 kg + 300 kg		Shoe: 450 mm		Dozer: Blade up			
B	A	1.5 m		3.0 m		4.5 m		6.0 m		At max. reach		Radius	
													
6.0 m	kg					2,040	1,750			*1,660	1,540	4.83 m	
4.5 m	kg					2,060	1,770	1,200	1,030	1,170	1,010	6.12 m	
3.0 m	kg			3,750	3,110	*1,590	*1,590	1,190	1,020	960	820	6.76 m	
1.5 m	kg			3,180	2,580	1,720	1,450	1,120	950	880	740	6.97 m	
G.L.	kg	*2,650	*2,650	*1,730	*1,730	1,590	1,330	1,060	900	890	750	6.79 m	
-1.5 m	kg	*4,650	*4,650	2,990	2,410	1,570	1,310	1,040	870	1,020	860	6.18 m	
-3.0 m	kg	*6,570	*6,570	3,190	2,590	*1,160	*1,160			*860	*860	4.95 m	

SK85MSR		Arm: 2.13 m		Bucket: Without		Counterweight: 1,050 kg		Shoe: 450 mm		Dozer: Blade up			
B	A	1.5 m		3.0 m		4.5 m		6.0 m		At max. reach		Radius	
													
6.0 m	kg					2,050	1,760			*1,660	1,550	4.83 m	
4.5 m	kg					2,070	1,780	1,210	1,040	1,180	1,020	6.12 m	
3.0 m	kg			3,780	3,130	*1,590	*1,590	1,200	1,030	960	820	6.76 m	
1.5 m	kg			3,210	2,600	1,730	1,460	1,130	960	880	750	6.96 m	
G.L.	kg	*2,650	*2,650	*1,730	*1,730	1,600	1,340	1,070	900	900	760	6.76 m	
-1.5 m	kg	*4,650	*4,650	3,010	2,430	1,580	1,320	1,050	880	1,030	870	6.18 m	
-3.0 m	kg	*6,570	*6,570	3,210	2,610	*1,160	*1,160			*860	*860	4.95 m	

SK85MSR		Arm: 1.87 m		Bucket: Without		Counterweight: 700 kg + 300 kg		Shoe: 450 mm		Dozer: Blade up			
B	A	1.5 m		3.0 m		4.5 m		6.0 m		At max. reach		Radius	
													
6.0 m	kg									*2,000	1,800	4.41 m	
4.5 m	kg					*1,720	*1,720			1,290	1,110	5.81 m	
3.0 m	kg			3,650	3,010	1,900	1,620	1,190	1,020	1,030	890	6.49 m	
1.5 m	kg			3,190	2,590	1,710	1,450	1,120	960	940	800	6.70 m	
G.L.	kg	*3,050	*3,050	2,960	2,380	1,610	1,350	1,080	910	960	820	6.52 m	
-1.5 m	kg	*5,310	*5,310	*3,030	2,470	1,600	1,340			1,110	950	5.87 m	
-3.0 m	kg			*2,620	*2,620					*760	*760	4.54 m	

SK85MSR		Arm: 1.87 m		Bucket: Without		Counterweight: 1,050 kg		Shoe: 450 mm		Dozer: Blade up			
B	A	1.5 m		3.0 m		4.5 m		6.0 m		At max. reach		Radius	
													
6.0 m	kg									*2,000	1,810	4.41 m	
4.5 m	kg					*1,720	*1,720			1,300	1,120	5.81 m	
3.0 m	kg			3,680	3,030	1,910	1,630	1,200	1,030	1,040	890	6.49 m	
1.5 m	kg			3,220	2,610	1,720	1,460	1,130	970	950	810	6.70 m	
G.L.	kg	*3,050	*3,050	2,980	2,400	1,620	1,360	1,090	920	970	820	6.52 m	
-1.5 m	kg	*5,310	*5,310	*3,030	2,490	1,610	1,350			1,120	950	5.87 m	
-3.0 m	kg			*2,620	*2,620					*760	*760	4.54 m	

Note:

- Do not attempt to lift or hold any load that is greater than these lift capacities at their specified lift point radius and heights. Weight of all accessories must be deducted from the above lift capacities.
- Lift capacities are based on machine standing on level, firm, and uniform ground. User must make allowance for job conditions such as soft or uneven ground, out of level conditions, side loads, sudden stopping of loads, hazardous conditions, experience of personnel, etc.
- Arm top defined as lift point.
- The above lifting capacities are in compliance with ISO 10567. They do not exceed 87% of hydraulic lifting capacity or 75% of tipping load. Lifting capacities marked with an asterisk (*) are limited by hydraulic capacity rather than tipping load.
- Operator should be fully acquainted with the Operator's and Maintenance Instructions before operating this machine. Rules for safe operation of equipment should be adhered to at all times.
- Lift capacities apply to only machine as originally manufactured and normally equipped by KOBELCO CONSTRUCTION MACHINERY CO., LTD.

STANDARD EQUIPMENT

ENGINE

- Engine, YANMAR 4TNV98CT, Diesel engine with turbocharger and intercooler, EU Stage V compliant
- Auto Idle Stop
- Automatic engine deceleration
- Batteries (2 x 12 V - 72 Ah)
- Starting motor (24 V - 3.5 kW), 50 amp alternator
- Engine oil pan drain cock
- Double element air cleaner
- Refueling pump

CONTROL

- Working mode selector (H-mode, S-mode and ECO-mode)
- N&B piping (proportional hand controlled)
- Extra piping (proportional hand controlled)
- Object Handling Kit (boom and arm safety valves)

SWING SYSTEM & TRAVEL SYSTEM

- Swing rebound prevention system
- Straight propel system
- Two-speed travel with automatic shift down
- Sealed & lubricated track links
- 450 mm steel shoes
- Grease-type track adjusters
- Automatic swing brake
- Lower Frame Guard
- Dozer Blade

MIRRORS, LIGHTS & CAMERAS

- Rear view mirror, rear view camera and right side view camera
- Three front working lights (LED)

OPTIONAL EQUIPMENT

- Various optional arms
- Wide range of shoes
- Front-guard protective structure (may interfere with bucket action)
- Additional counterweight (+300 kg)
- Cab top work LED lights (two lights)

CAB & CONTROL

- Two control levers, pilot-operated
- Horn, electric
- Integrated left-right slide-type control box
- LED door light (interior)
- Coat hook
- Large cup holder
- Detachable two-piece floor mat
- GRAMMER air suspension seat with heater
- Retractable seatbelt
- Headrest
- Handrails
- Intermittent Parallel wiper with double-spray washer
- Skylight
- Openable top guard (ISO 10262: 1998)
- Tinted safety glass
- Pull-type front window and removable lower front window
- Easy-to-read 10-inch LCD SCREEN multi-display monitor
- Automatic air conditioner
- Emergency escape hammer
- Radio (AUX & Bluetooth)
- 12 V converter
- Hands-free telephone
- USB port

- Mechanical suspension seat (Applicable for N&B piping)
- Rain visor (may interfere with bucket action)
- Quick Hitch piping
- Heavier counterweight (+350 kg)
- Eagle eye view

Note: Standard and optional equipment may vary. Consult your KOBELCO dealer for specifics.

Note: This catalogue may contain attachments and optional equipment that are not available in your area. And it may contain photographs of machines with specifications that differ from those of machines sold in your areas. Please consult your nearest KOBELCO distributor for those items you require. Due to our policy of continuous product improvements all designs and specifications are subject to change without advance notice.

Copyright by **KOBELCO CONSTRUCTION MACHINERY CO., LTD.** No part of this catalogue may be reproduced in any manner without notice.

KOBELCO CONSTRUCTION MACHINERY EUROPE B.V.

Veluwezoom 15
1327 AE Almere
The Netherlands
www.kobelco-europe.com

Enquiries To: